

Audio IC Application Circuit

TAN-320

5 V FM, SW2, SW1, MW Single-chip Tuner IC
TA2111N

1. Outline

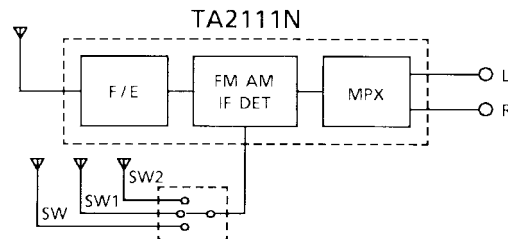

This application circuit example is for a three-band (FM, SW2, SW1, MW) 5 V tuner circuit. The IC is a single-chip TA2111N which incorporates all circuits from RF to MPX. Four bands are supported by switching an antenna and an oscillator circuit using a six-circuit four-contact lever switch. Signal frequencies are tuned using polyvaricons.

2. Ratings

Characteristics	Rating			
	FM	SW2	SW1	MW
Supply voltage	5 V			
Current dissipation (quiescent)	14 mA	8 mA		
Signal frequency range	87.5~108 MHz	6.7~22.5 MHz	2.2~7.3 MHz	520~1650 kHz
Intermediate frequency	10.7 MHz	455 kHz		
Sensitivity	14.5dB μ V EMF (S/N = 30dB)	4dB μ V EMF ($V_o = 10$ mVrms)	4dB μ V EMF ($V_o = 10$ mVrms)	32dB μ V/m ($V_o = 10$ mVrms)

3. Cautions on Use

- (1) To reduce spurious signals in the FM frequency range in the SW1 or SW2 band, an inductor (1 μ H) is inserted next to the AMRF input pin (pin 24).
- (2) Insert a resistor (33 Ω) next to the AM OSC pin (pin 20). In the lower part of the frequency range, if the load impedance of the oscillator circuit drops lower than that of the parasitic circuit (indicated by the dots in Figure 1), oscillation frequency of the parasitic circuit may stop. To avoid signals not being received due to the above, insert a resistor to lower the Q of the parasitic circuit.

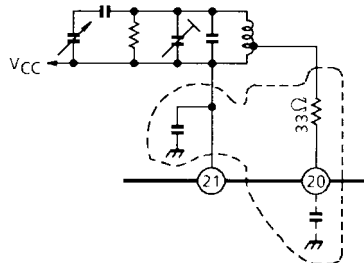

Figure 1

- (3) To reduce the stray capacitance of the circuit board (pattern), the primary side of the SW1/SW2 antenna coil is input from the tap.
- (4) The characteristics of the SW1 and SW2 bands are measured using the pseudo antenna circuit shown in Figure 2 below :

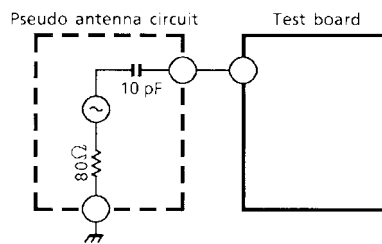
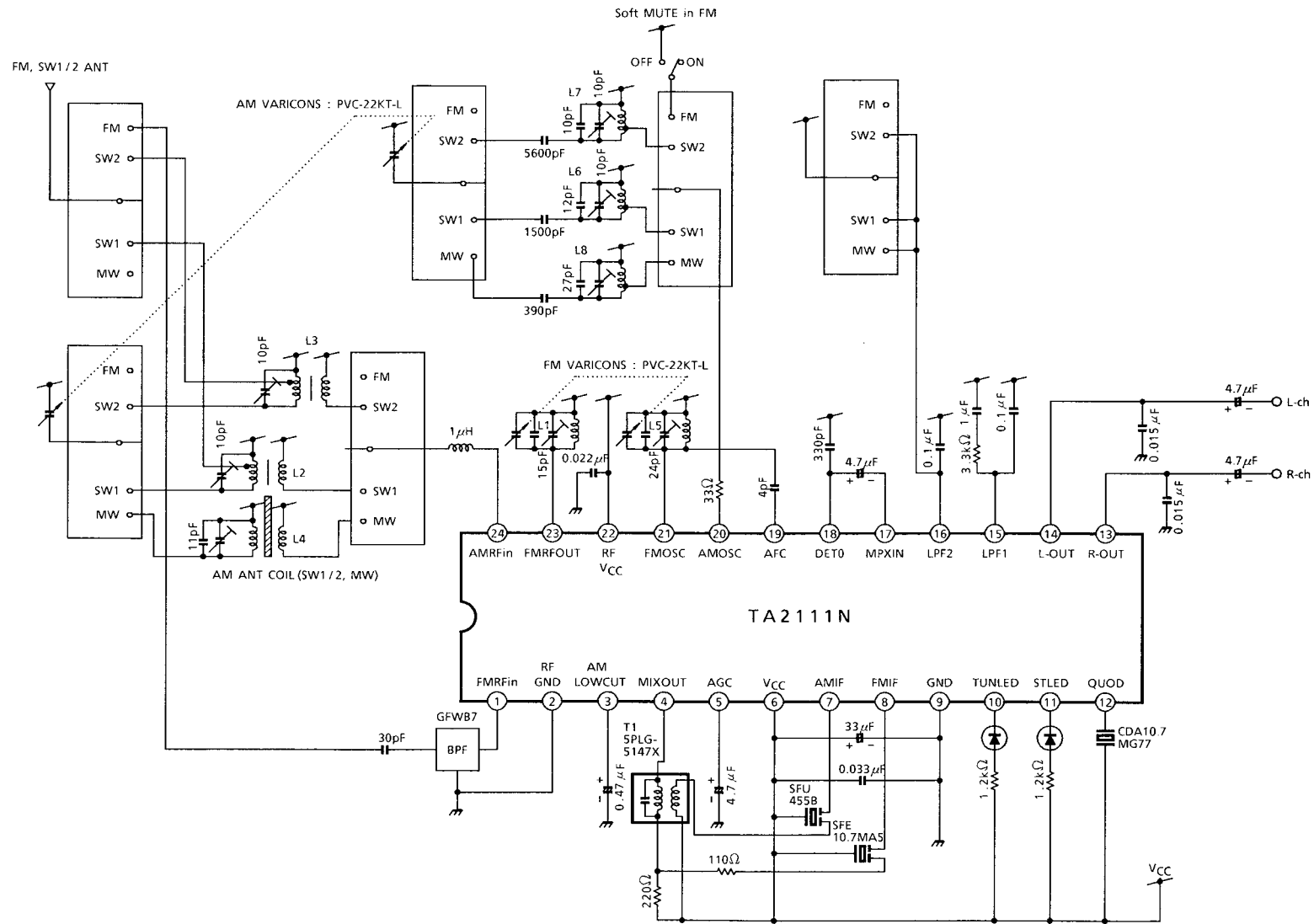

Figure 2

TA2111N-3BAND (FM, SW1, SW2) Application Circuit



TA2111N-3BAND (FM, SW1, SW2, MW) Coil Specification

No.	Stage	f (Hz)	L (μH)	C (pF)	Q (min)	Turns					Wire (mm)	Note
						1-2	2-3	1-3	1-4	4-6		
L1	FM RF	100M	0.06	—	100	—	—	2 1/4	—	—	0.5 UEW	0258-000-021@S
L2	SW1 ANT	2.52M	17	—	75	16	11	27	—	11	0.08 MUEW	4148-T024@S
L3	SW2 ANT	7.96M	1.7	—	70	6	3	9	—	5	0.12 MUEW	4148-T026@S
L4	MW ANT	796k	279	—	200	—	68 (1-2)	—	13 (3-4)	—	7/0.07 USTC	MSE-0119@M
L5	FM OSC	100M	0.045	—	100	—	—	1 3/4	—	—	0.5 UEW	0258-000-020@S
L6	SW1 OSC	2.52M	12.4	—	125	7	16	—	—	—	0.08 UEW	4148-3099-176@S
L7	SW2 OSC	7.96M	1.4	—	85	4	4	—	—	—	0.12 UEW	4148-3167-079@S
L8	MW OSC	796k	120	—	120	13	56	—	—	—	0.07 UEW	A7BRS-12552Y@T
T1	MW IFT	455k	—	470	60	—	—	109	—	7	0.05 UEW	5PLG-5147X@T

S: SUMIDA ELECTRIC CO., LTD

M: MITSUMI (SEGAMAT) SDN. BHD

T: Toko, inc

(bottom view)

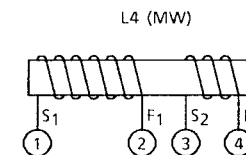
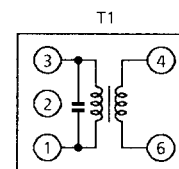
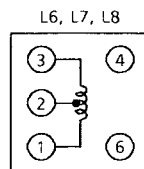
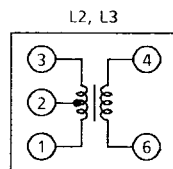
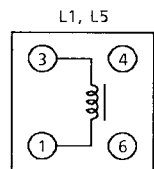

Example of Printed Circuit Board Pattern

TOSHIBA
TA2111N-3BAND

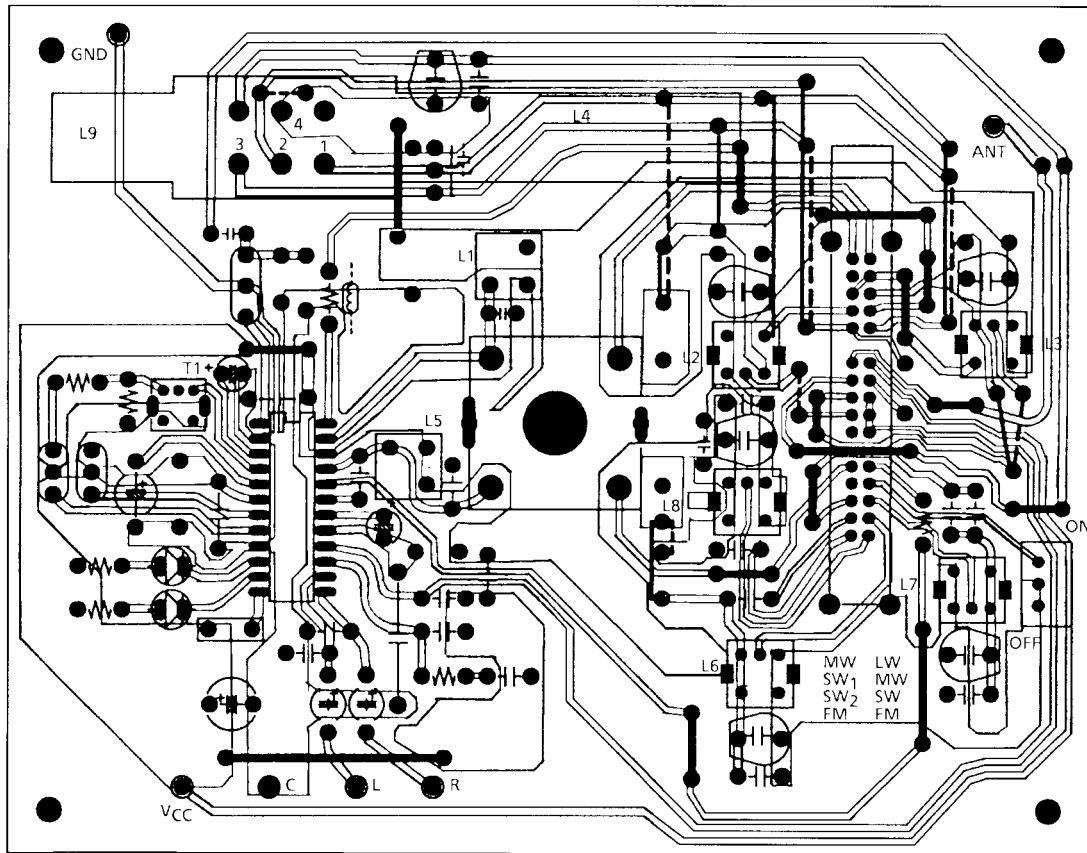

- COMMON JUMPER
- LW MW SW FM
- - - MW SW₁ SW₂ FM

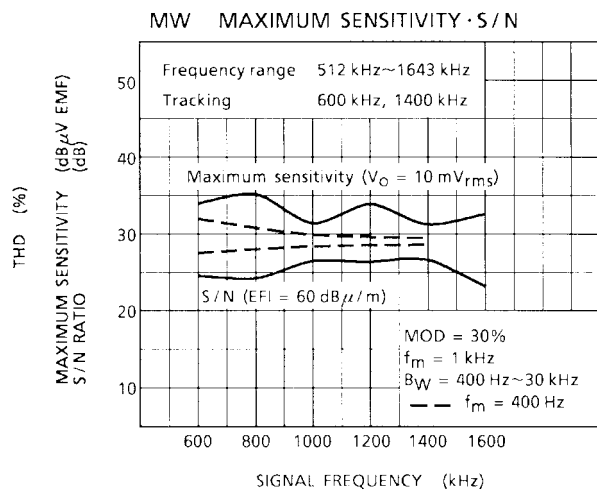
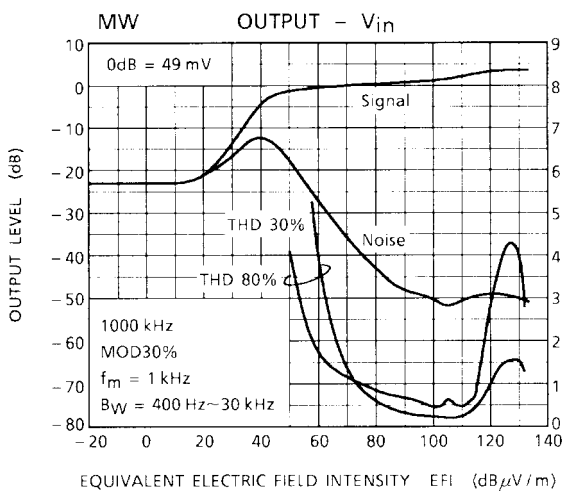
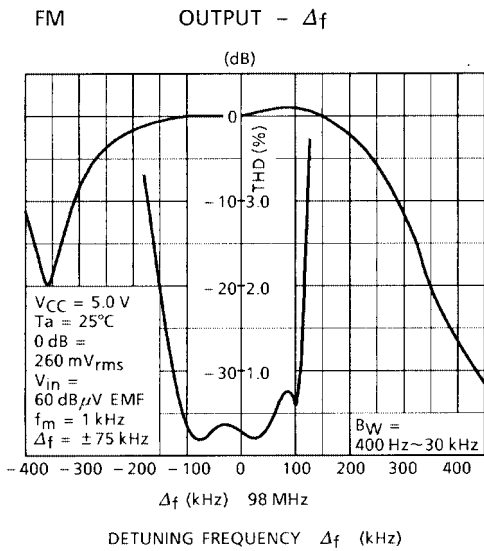
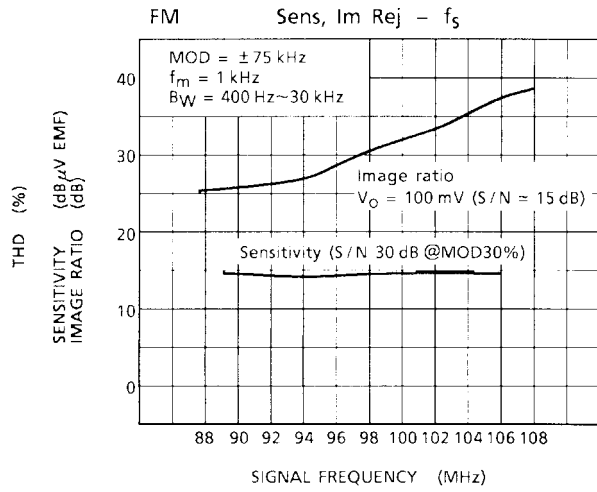
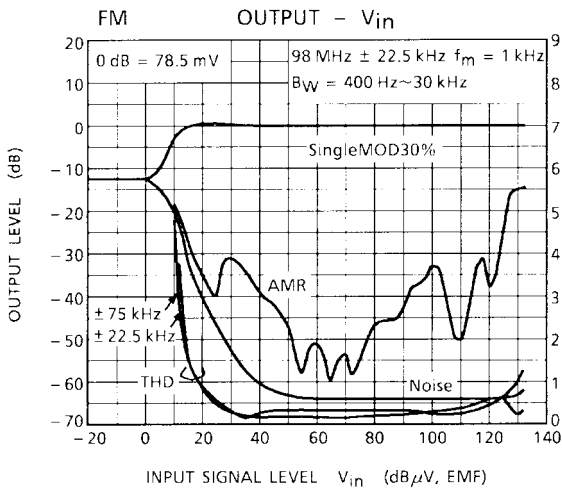

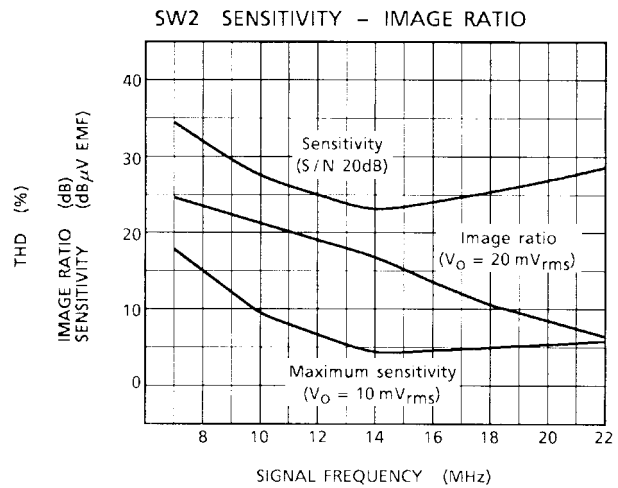
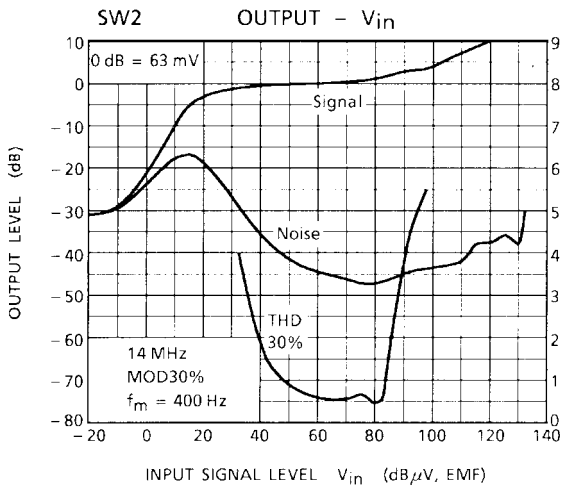
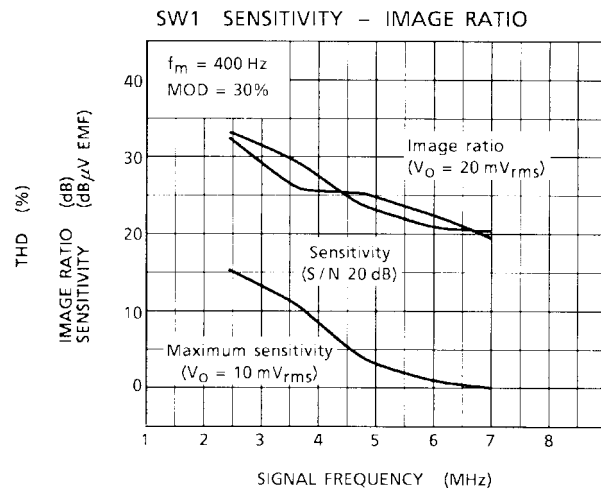
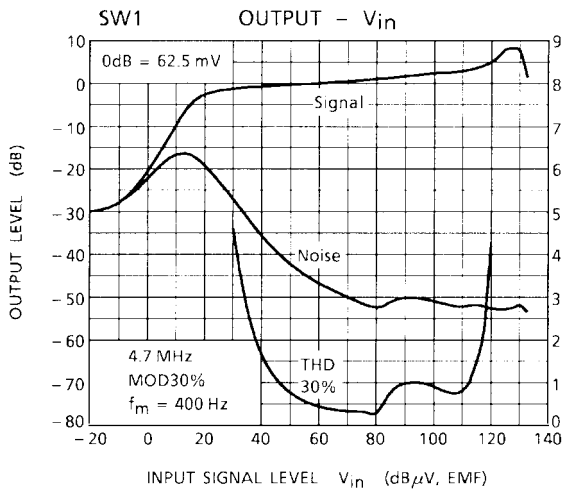

RESTRICTIONS ON PRODUCT USE

000707EBA

- TOSHIBA is continually working to improve the quality and reliability of its products. Nevertheless, semiconductor devices in general can malfunction or fail due to their inherent electrical sensitivity and vulnerability to physical stress. It is the responsibility of the buyer, when utilizing TOSHIBA products, to comply with the standards of safety in making a safe design for the entire system, and to avoid situations in which a malfunction or failure of such TOSHIBA products could cause loss of human life, bodily injury or damage to property.
In developing your designs, please ensure that TOSHIBA products are used within specified operating ranges as set forth in the most recent TOSHIBA products specifications. Also, please keep in mind the precautions and conditions set forth in the "Handling Guide for Semiconductor Devices," or "TOSHIBA Semiconductor Reliability Handbook" etc..
- The TOSHIBA products listed in this document are intended for usage in general electronics applications (computer, personal equipment, office equipment, measuring equipment, industrial robotics, domestic appliances, etc.). These TOSHIBA products are neither intended nor warranted for usage in equipment that requires extraordinarily high quality and/or reliability or a malfunction or failure of which may cause loss of human life or bodily injury ("Unintended Usage"). Unintended Usage include atomic energy control instruments, airplane or spaceship instruments, transportation instruments, traffic signal instruments, combustion control instruments, medical instruments, all types of safety devices, etc.. Unintended Usage of TOSHIBA products listed in this document shall be made at the customer's own risk.
- The products described in this document are subject to the foreign exchange and foreign trade laws.
- The information contained herein is presented only as a guide for the applications of our products. No responsibility is assumed by TOSHIBA CORPORATION for any infringements of intellectual property or other rights of the third parties which may result from its use. No license is granted by implication or otherwise under any intellectual property or other rights of TOSHIBA CORPORATION or others.
- The information contained herein is subject to change without notice.